



REQUEST FOR QUOTATION

Date: 09 November 2023
RFQ No.: R1 100-23-07-1982

Name of Company: _____
Address: _____
Name of Store/Shop: _____
Address: _____
TIN: _____
PhilGEPS Registration Number: _____

The City Government of Pasig, through the Bids and Awards Committee (BAC), intends to procure **Supply, Delivery, and Installation of CCTV Cameras, Monitor and Accessories – City Veterinary Office** with an Approved Budget for the Contract (ABC) of **Php 470,730.80**, in accordance with **Section 53.9** of the 2016 revised Implementing Rules and Regulations of Republic Act No. 9184. Please quote your best offer for the item in the table below.

The Project shall be awarded as One Project having several items that shall be awarded as one contract. Quotations received exceeding each total Cost per Item and/or the total Approved Budget for the Contract shall be rejected.

Item No.	Item Description	Brand Name (PLEASE DO NOT LEAVE BLANK)	QTY	UOM	Approved Budget		Price Offer	
					Unit Cost	Total Cost	Unit cost	Total Cost
Supply, Delivery and Installation of CCTV Cameras, Monitor and Accessories and Labor								
1	CCTV Cameras, Monitor and Complete Accessories		40	units	11,768.27	470,730.80		
Note: Other terms and conditions are stipulated in the attached Terms of Reference, if any.					Total	470,730.80		
DELIVERY TERM: Please refer to the Terms of Reference.								

**Indicate the BRAND NAME or MANUFACTURER NAME and the specific MODEL to be offered or attach a BROCHURE for the offered item; items including but not limited to clothing, vehicle, equipment, devices, electronics, machines, drugs, medicines, medical supplies must be branded or at the very least, manufacturer shall be indicated.*



TERMS OF REFERENCE

PROJECT TITLE: Supply, Delivery & Installation of 40 units of CCTV Camera

LOCATION: Pasig Slaughterhouse San Sebastian St. Iluigin Phase II, Pinagbuhatan, Pasig City

I. General Information:

Pasig City Slaughterhouse has newly constructed Holding Pens, slaughter area, different offices, and other facilities inside the compound; hence, monitoring of its facilities, day and night slaughtering operations, receiving of food animals, and dispatching of its carcasses are indispensable. Installation of CCTV Cameras would help the management in monitoring the entire slaughterhouse.

II. Scope of Works:

Materials and Accessories to be supplied and used in installation:

1	Bullet CCTV IP Camera 2MP-4MP Build-in -advanced IR with long-range -built-in-microphone for real-time audio security -water and dust resistant	40	Units
2	16 Channel 1U 16 PoE 4K Network Video Recorder - up to 16 ch IP camera input - with at least H265 – H266 + video formats, plug and play - 1 HDMI and 1 VGA interface, both interfaces support independent video output - 2 SATA interfaces for SSD connection (up to 10TB capacity per SSD) -Up to 160 Mbps incoming bandwidth	2	units
3	8 Channel 1U 8 PoE 4K Network Video Recorder - up to 16 ch IP camera input - with at least H265 – H266 + video formats, plug and play - 1 HDMI and 1 VGA interface, both interfaces support independent video output - 2 SATA interfaces for SSD connection (up to 10TB capacity per SSD) -Up to 80 Mbps incoming bandwidth	1	Unit
4	5-Port Gigabit Desktop Switch Hub -up to 10/100/1000Mbps - save the power up to 84% -steel housing, desktop or wall-mounting design		
5	Cat6 UTP (Unshielded Twisted Pairs) Cable -1000 feet (305 meters)/roll -Inside Material: (Copper Clad Aluminum) -For indoor and outdoor use -Apply to Telecommunication/CCTV/PoE device	2	Rolls
6	UPS (Uninterruptible Power Supply) -Power Rating: at least 650VA/1000VA -Voltage Range: 140-290V -Frequency: 50/60hz+5% -Voltage inverter – 20V +10% -Maximum Wattage: 350 to 400 watts	1	unit
7	Electrical Lining of CAT6 UTP Cable	1	Lot
8	SSD (Solid State Drive) for NVR 10 TB capacity	2	units
9	SSD (Solid State Drive) for NVR 8 TB capacity	1	unit
10	RJ45 Metal Shielded Connector	100	pcs
11	RJ45 Rubberboots for Cat 6 color: purple	100	Pcs
	12V DC Male Plug Connector for CCTV Camera	50	Pcs



Caruncho Avenue, Brgy. San Nicolas, Pasig City, Philippines 1600



(02) 8643-1111 * (02) 8641-1111 loc 1461 * bidsandawards@pasigcity.gov.ph *



pasigcity.gov.ph



12	32-inch LED Flat Screen TV Weight: up to 5 kg Input voltage: AC 100 V – 240 V 50/60Hz Resolution: at least 1,366 X 768 WXGA Picture: High Dynamic Range Sound: Original Surround Connectivity: HDMI/USB Warranty: 2 years	3	units
13	3D Braided HDMI Cable 2.0 (3 meters)	3	pcs.
14	4 Universal outlets extension cord (3 meters)	3	Pcs
15	Installation and Labor	1	Lot

III. Terms:



- Supply and Installation within 90 working days
- To be installed with the attached location
- Location of another 10 units to be installed in the entire Holding Pens
- Warranty One (1) Year after signing the acceptance report

Prepared and Certified by:

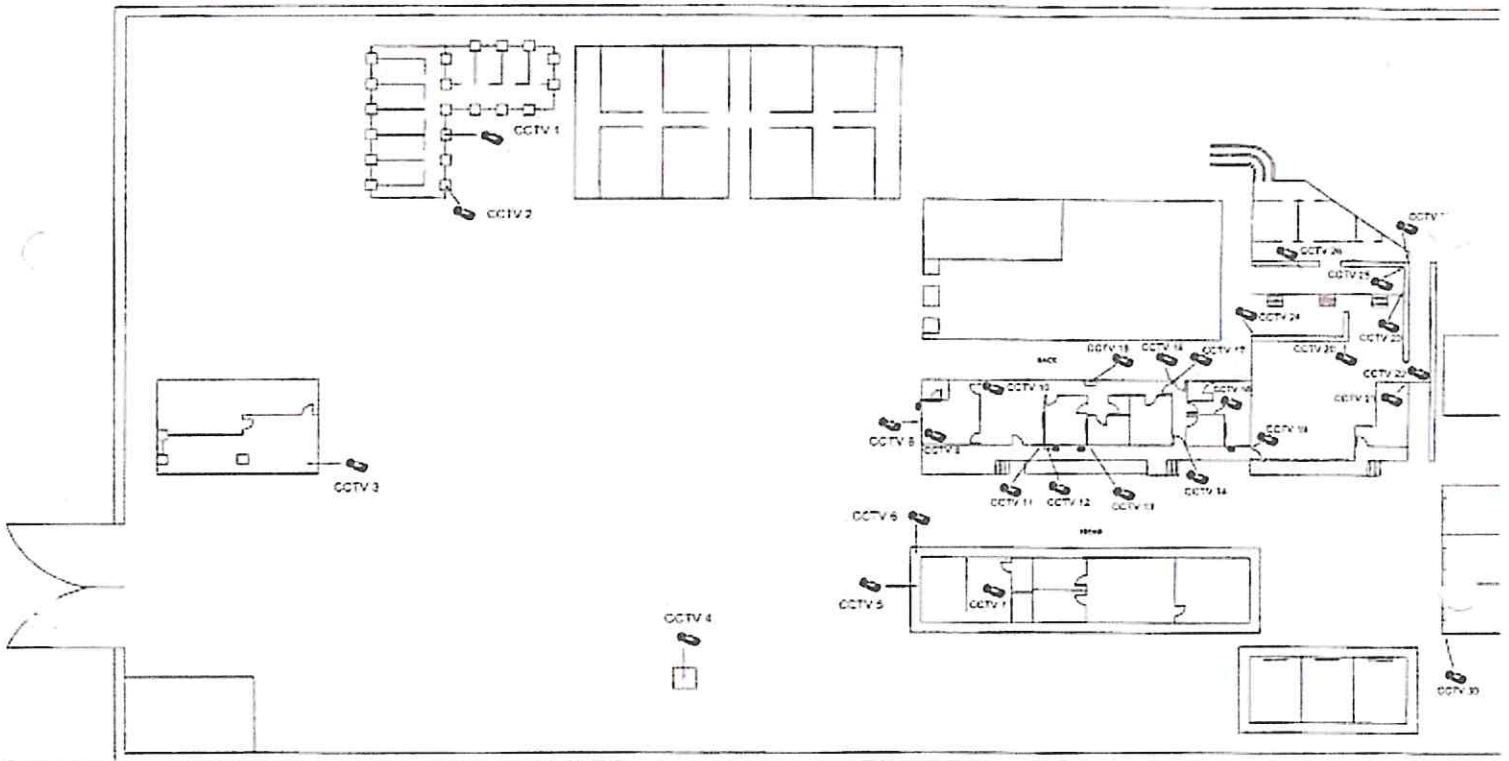
SUSAN A. RAPSING
Acting SLH Head/PCO



Caruncho Avenue, Brgy. San Nicolas, Pasig City, Philippines 1600

 (02) 8643-1111 * (02) 8641-1111 loc 1461 *  bidsandawards@pasigcity.gov.ph *

 pasigcity.gov.ph

Page 3 of 9 | RFQ No. R1 100-23-07-1982 | RLD

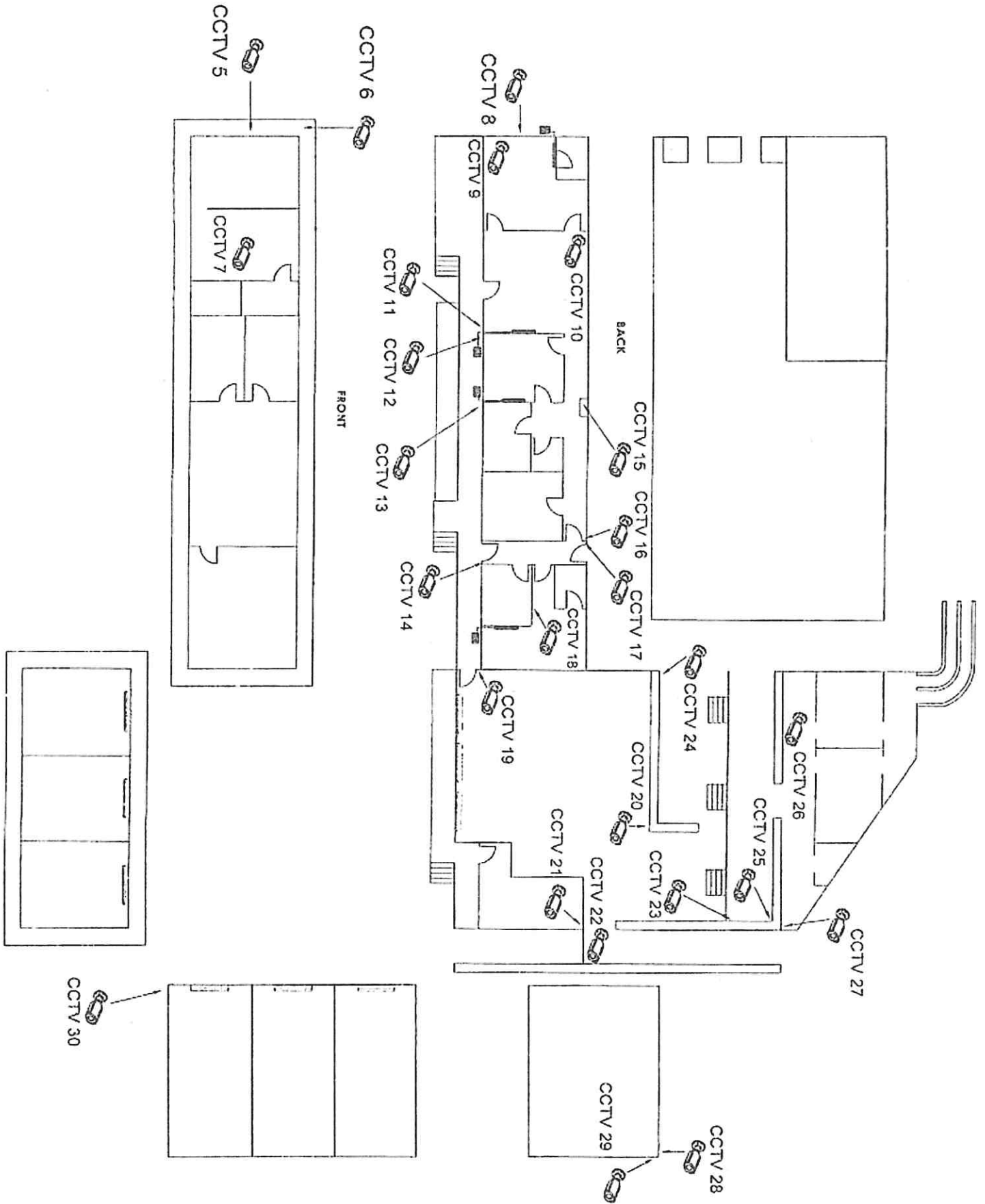

Caruncho Avenue, Brgy. San Nicolas, Pasig City, Philippines 1600

(02) 8643-1111 * (02) 8641-1111 loc 1461 * bidsandawards@pasigcity.gov.ph *

pasigcity.gov.ph

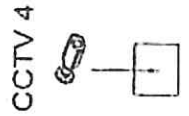
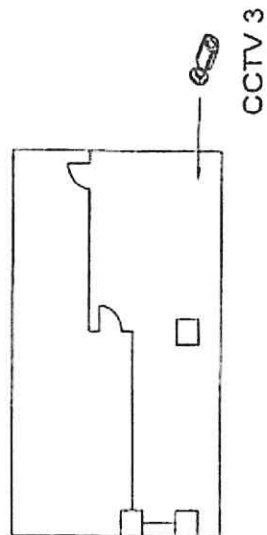
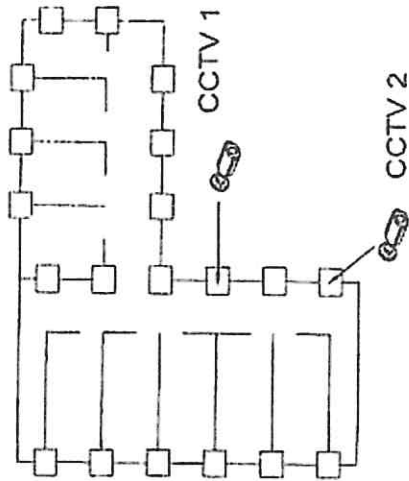
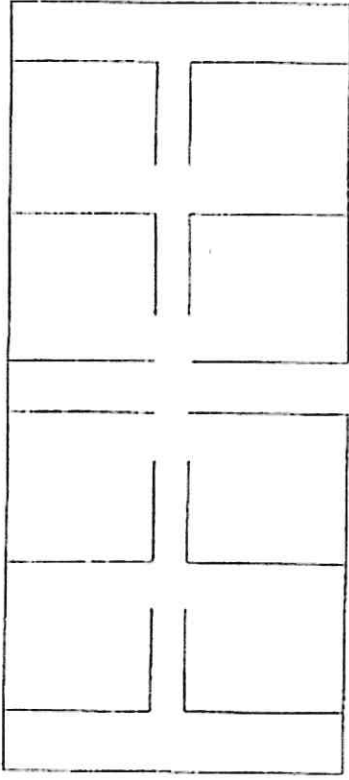

Caruncho Avenue, Brgy. San Nicolas, Pasig City, Philippines 1600

(02) 8643-1111 * (02) 8641-1111 loc 1461 * bidsandawards@pasigcity.gov.ph *

pasigcity.gov.ph

Page 5 of 9 | RFQ No. R1 100-23-07-1982 | RLD

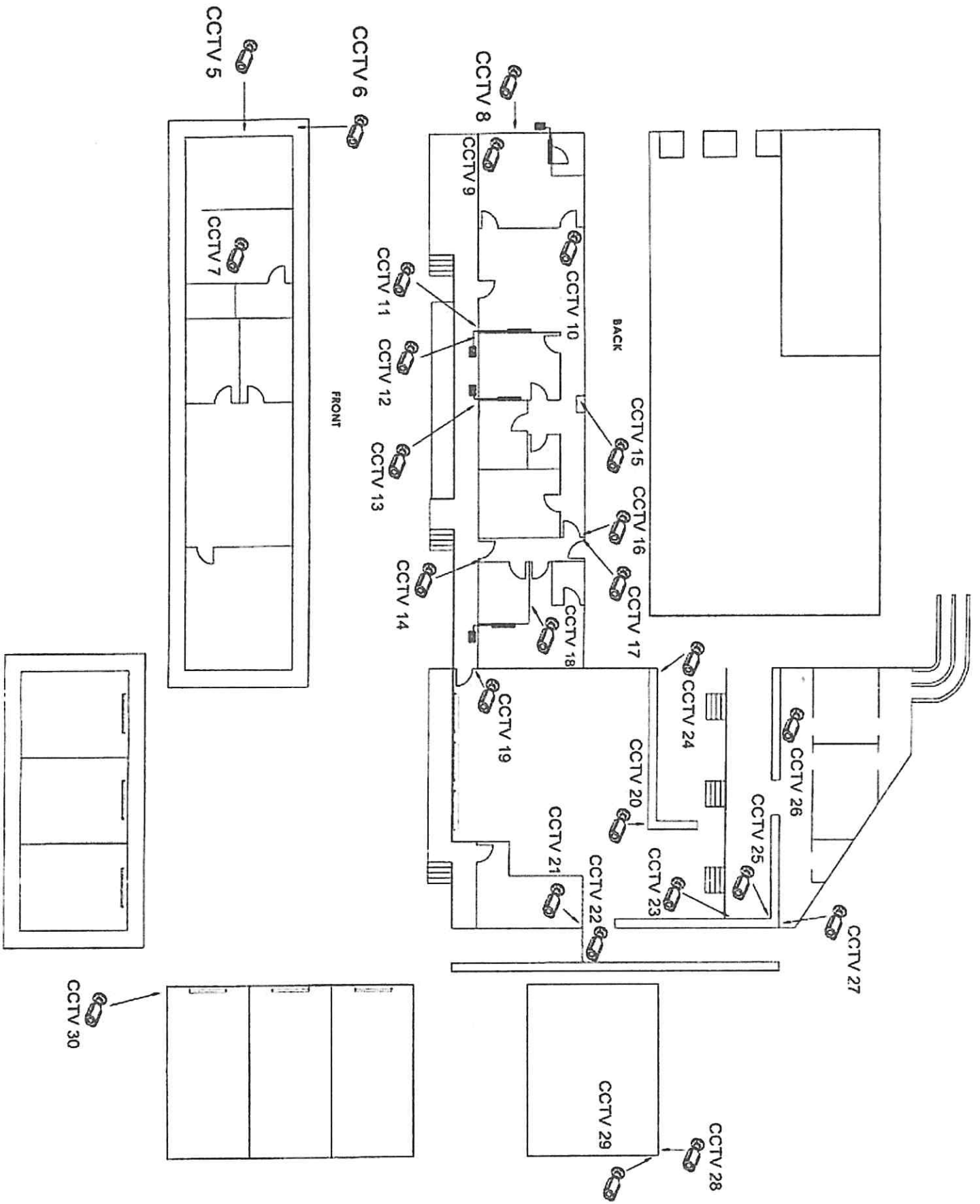

Caruncho Avenue, Brgy. San Nicolas, Pasig City, Philippines 1600

(02) 8643-1111 * (02) 8641-1111 loc 1461 * bidsandawards@pasigcity.gov.ph *

pasigcity.gov.ph

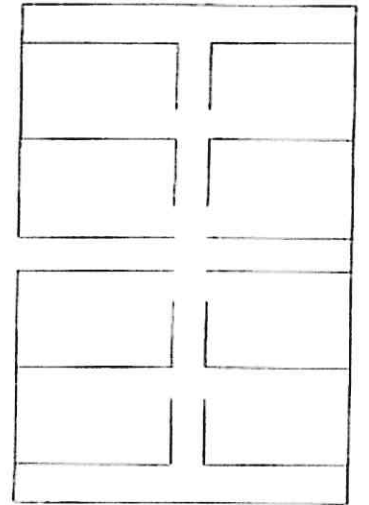
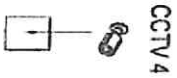
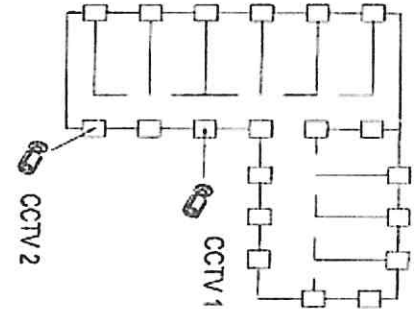
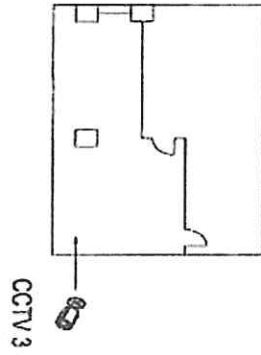



Submit this Quotation (Accomplished and duly signed by the Owner or the respective Authorized Representative indicated in the Secretary's Certificate/Special Power of Attorney) not later than the closing date specified in the Bid Notice Abstract posted in PhilGEPS website along with the following documents:

- **Mayor's/Business Permit** (or a recently expired Mayor's/Business permit together with the official receipt as proof that the prospective bidder has applied for renewal within the period prescribed by the concerned local government unit subject to submission of the Mayor's Permit before the award of contract). The nature of business as stated in the Mayor's/Business Permit should at the very least be similar or related to the project to be bid.
- **PhilGEPS Registration Number**
- **Income Tax Return** - Latest Income or Business Tax Returns filed and paid through the BIR Electronic Filing and Payment System (EFPS).

In accordance with Revenue Regulation No. 3-2005, the above-mentioned tax returns shall refer to the following:

Caruncho Avenue, Brgy. San Nicolas, Pasig City, Philippines 1600

 (02) 8643-1111 * (02) 8641-1111 loc 1461 *  bidsandawards@pasigcity.gov.ph *

 pasigcity.gov.ph

1. Latest Income Tax Return (ITR) - For participants already with an Annual ITR, latest ITR shall refer to the ITR for the preceding Tax Year be it on a calendar or fiscal year. For new establishments which, therefore, have no annual ITR yet, it shall refer to the most recent quarter's ITR.
 2. Latest Business Tax Return - refers to the Value Added Tax (VAT) or Percentage Tax returns covering the previous six (6) months.
- Accomplished and notarized **Omnibus Sworn Statement** ([https://www.gppb.gov.ph/assets/forms/Omnibus%20Sworn%20Statement\(Revised\).docx](https://www.gppb.gov.ph/assets/forms/Omnibus%20Sworn%20Statement(Revised).docx))
 - **Proof of Authorization: Secretary's Certificate** if corporation, or **Special Power of Attorney**, if individual.

ADDITIONAL REQUIREMENTS:

For Procurement of Drugs and Medicines:

Documents from the Food and Drug Administration (FDA):

- a. Certificate of Product Registration;
- b. Certificate of Good Manufacturing Practice;
- c. License to Operate;
- d. Batch Release Certificate (*for vaccines, toxoids and immunoglobulins only*) [*to be submitted upon delivery*]; and
- e. Certificate of Analysis (*for anesthesia and antibiotics*) [*to be submitted upon delivery*].

If the Supplier is not the Manufacturer, a certification from the Manufacturer that the supplier is an authorized distributor/dealer of the products/items.

Please submit the accomplished Quotation and required documents on or before the deadline of submission at the Bids and Awards Committee (BAC) through the **Procurement Management Office (BAC Secretariat Office), 4th Floor, Pasig City Hall, San Nicolas, Pasig City.**

All documents should be submitted in a sealed brown envelope addressed to the "Bids and Awards Committee, 4th Floor, Pasig City Hall", and properly marked with the Project Title as provided herein.

The CITY GOVERNMENT OF PASIG reserves the right to reject any and all bids, declare a failure of bidding, or not award the contract at any time prior to contract award in accordance with Sections 35.6 and 41 of the 2016 revised IRR of RA No. 9184, without thereby incurring any liability to the affected bidder or bidders.

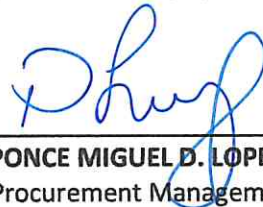

For any clarification, you may contact us at telephone no. (02) 8641-1111 / (02) 8643-1111 loc. 1461 or email address at bidsandawards@pasigcity.gov.ph



ATTY. PONCE MIGUEL D. LOPEZ
Officer in Charge, Procurement Management Office

I hereby certify that I have read and agree to this Request for Quotation, its Terms of Reference, and Bid Bulletin/s, if any. I further certify that the products to be delivered will conform to the specifications stated in the Item Description.

Caruncho Avenue, Brgy. San Nicolas, Pasig City, Philippines 1600

 (02) 8643-1111 * (02) 8641-1111 loc 1461 *  bidsandawards@pasigcity.gov.ph *

 pasigcity.gov.ph

Page 8 of 9 | RFQ No. R1 100-23-07-1982 | RLD



Conforme:

Signature over Printed Name

Position

Duly authorized to sign quotation/offer for and on behalf of _____
(Please indicate Company Name)

Caruncho Avenue, Brgy. San Nicolas, Pasig City, Philippines 1600

 (02) 8643-1111 * (02) 8641-1111 loc 1461 *  bidsandawards@pasigcity.gov.ph *

 pasigcity.gov.ph

Page 9 of 9 | RFQ No. R1 100-23-07-1982 | RLD